



CZECH

TECHNISCHES BLATT
SCHEDA TECNICA
DATA SHEET
FICHE TECHNIQUE

CZECH

DESIGN HERMANN CZECH, 1994



Stuhl aus Buchenbugholz mit oder ohne Armlehnen. Sitz aus Schichtholz oder gepolstert. In der lackierten Ausführung mit oder ohne FüÙe in Buche Natur verfügbar.

Sedia e poltroncina in faggio curvato, con seduta in multistrato o imbottita. La versione laccata è disponibile con o senza gambaleto in faggio naturale.

Bent beech-wood chair and armchair, with plywood or upholstered seat. The lacquered version is available with or without natural beech feet.

Chaise et petit fauteuil en hêtre cintré, avec assise en contreplaqué ou rembourrée; la version laquée est disponible avec ou sans les pieds en hêtre naturel.

Silla y butaca de haya curvada con asiento en multicapa o tapizado. La versión lacada está disponible con o sin patas en haya natural.



SDCZECLGN

Dimensions mm.

height 850 | width 420 | depth 510



PTCZECLGN

Dimensions mm.

height 850 | width 550 | depth 510



SDCZECTES

Dimensions mm.

height 850 | width 420 | depth 510





PTCZECTES

Dimensions mm.

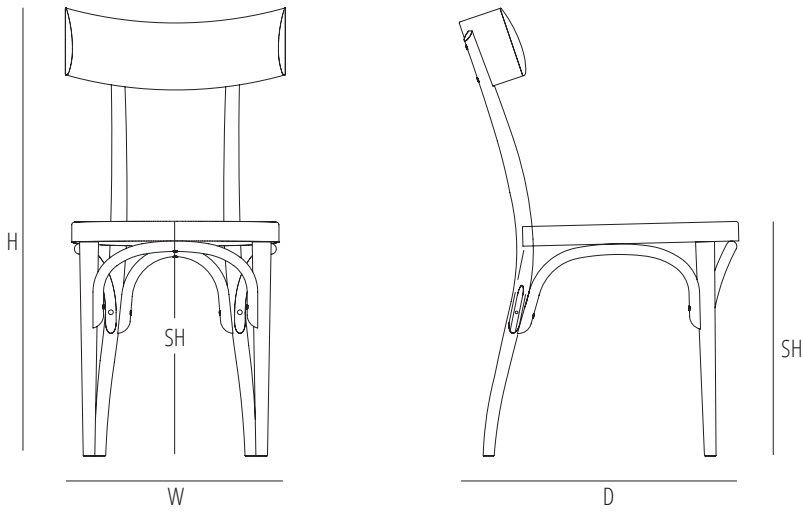
height 850 | width 550 | depth 510



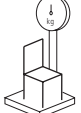
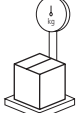
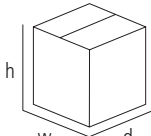

	H	W	D	SH	AH
mm	850	420	510	450	
inch	33,4	16,5	20,1	17,7	

 1
  max. 2
  0,36
  4
  7
 

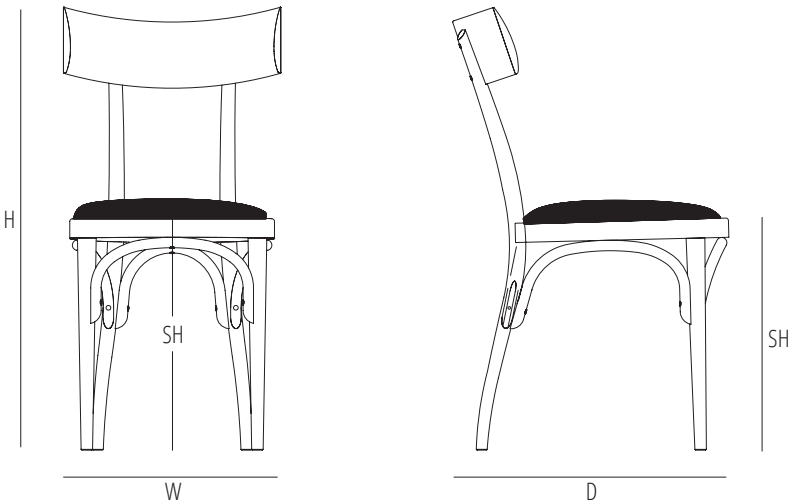
mm - inch
 h 960 - 37,7
 w 620 - 24,4
 d 600 - 23,6

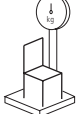
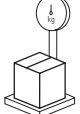
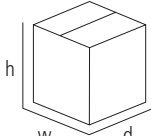

	H	W	D	SH	AH
mm	850	420	510	450	1 Pz/Pc: 50 cm. Linear x 140 cm h/width
inch	33,4	16,5	20,1	17,7	2 Pz/Pc: 50 cm. Linear x 140 cm h/width

 1
  max. 2
  0,36
  4
  7
 

mm - inch
 h 960 - 37,7
 w 620 - 24,4
 d 600 - 23,6

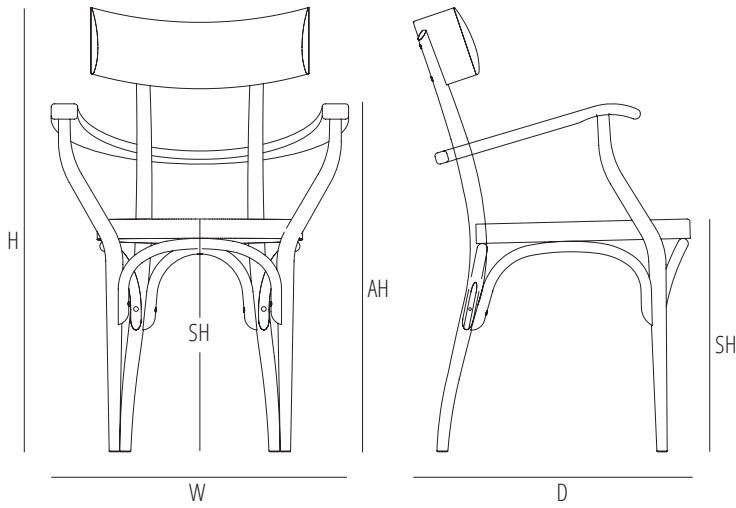

	H	W	D	SH	AH
mm	850	550	510	450	680
inch	33,4	21,6	20,1	17,7	26,7

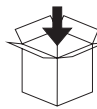

max. 1

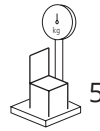
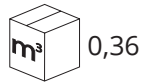

5

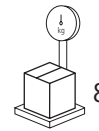

8

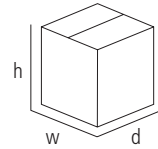

mm - inch
h 960 - 37,7
w 620 - 24,4
d 600 - 23,6

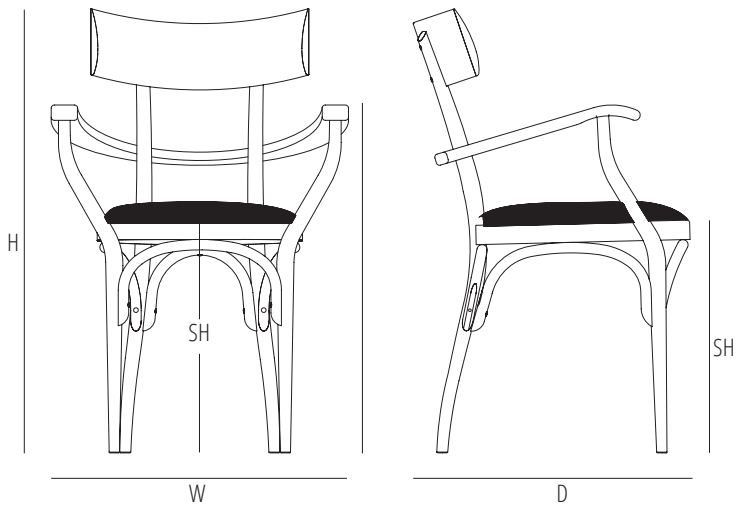

	H	W	D	SH	AH	
mm	850	550	510	450	680	1 Pz/Pc: 50 cm. Linear x 140 cm h/width
inch	33,4	21,6	20,1	17,7	26,7	2 Pz/Pc: 50 cm. Linear x 140 cm h/width

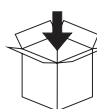

max. 1

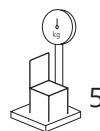
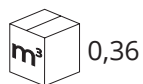

5

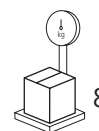

8

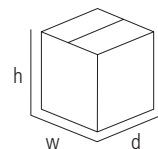

mm - inch
h 960 - 37,7
w 620 - 24,4
d 600 - 23,6

Verfuegbare Ausfuehrungen Finiture disponibili Available finishes Finitions disponibles



In der lackierten Ausfuehrung mit oder ohne FüÙe in Buche Natur verfuegbar (B01).
La versione laccata è disponibile con o senza gambaletto in faggio naturale (B01).
The lacquered version is available with or without natural beech feet (B01).
La version laquée est disponible avec ou sans les pieds en hêtre naturel (B01).

SOLID WOOD / ESSENZE NATURALI



B01 BEECH
B01 FAGGIO

STAINS / TINTI



B03 DARK WALNUT
B03 NOCE SCURO



B04 WENGÈ
B04 WENGÈ



B08 BEECH-WOOD STAINED IN NOCE CANALETTO
B08 FAGGIO TINTO NOCE CANALETTO

CLASSIC LACQUER / LACCATO CLASSICO



C01 - RAL 9005 BLACK

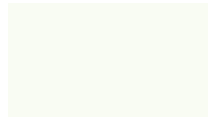

C02 - RAL 9010 PURE WHITE

CONTEMPORARY LACQUER / LACCATO CONTEMPORANEO



D01 - RAL 1013 PEARL WHITE



D02 - RAL 7047 TELEGREY 4



D03 - RAL 7030 STONE GREY



D19 - S7502 G DARK GREY



D21 - S1510 Y80R POWDER PINK



D29 - S3060 Y60R RED ORANGE



D26 - S3560 Y80R CARMINE RED



D14 - RAL 3005 WINE RED



D30 - S3030 B PASTEL BLUE



D11 - RAL 7000 SQUIRREL GREY



D12 - RAL 7031 BLUE GREY



D25 - RAL 5011 STEEL BLUE



D15 - RAL 5020 OCEAN BLUE



D27 - S1050 Y10R MELON YELLOW



D28 - S2050 G90Y CAMPUS GREEN



D23 - S6020 G10Y DARK GREEN

TESTS FOR CZECH

1. Seat impact resistance ANSI-BIFMA X5.1-2011/8
2. Backrest fatigue with non-tilting seat ANSI-BIFMA X5.1-2011/16
3. Fatigue strength of armrests ANSI-BIFMA X5.1-2011/13
4. Armrest resistance to vertical forces ANSI-BIFMA- X5.1-2011/13
5. Armrest resistance to horizontal forces ANSI-BIFMA X5.1-2011/14
6. Stability ANSI-BIFMA X5.1-2011/12
7. Backrest resistance ANSI-BIFMA X5.1-2011/18
8. Seat fatigue test ANSI-BIFMA X5.1-2011/11
9. Static load on front legs ANSI-BIFMA X5.1-2011/18
10. Static load on side legs ANSI-BIFMA X5.1-2011/18

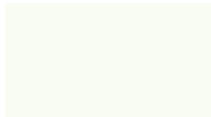

Gebrüder Thonet Vienna GmbH
Prinz Eugen Straße 42
1040 Wien (AT)

www.gebruederthonetvienna.com

Offices of the trademarks' licensee
Production Furniture International S.p.A.
Via Foggia, 23/H
10152 Torino (TO) Italy

Phone: 0039 011 0133330 - info@gebruederthonetvienna.com